

MX561-4, 0,06 KW, 4 polig, B35

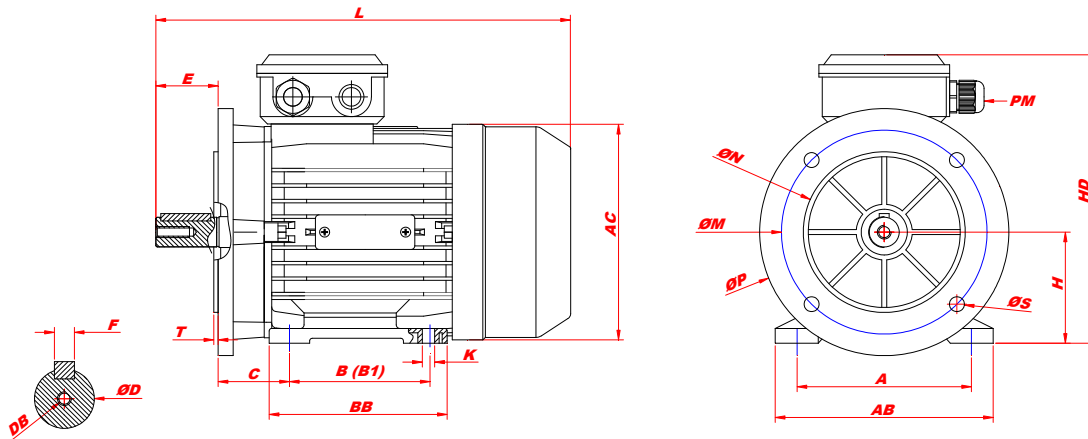

IEC 34-30

Maßblatt Drehstrommotor / dimensions three phase motor IM B35 [mm]

Typ	A	AB	AC	B	BB	C	PM	ØD	DB	E	F	H	HD	K	L
MX561-4	90	112,5	120	71	90	36	M16*1.5	9	M3	20	3	56	157	6	195
											ØP	ØN	ØM	ØS	
											120	80	100	7	

technische Daten / technical data

Typ / type	MX561-4			
Leistung / power	[kW]	0,06	Anzugs- zu Nennstrom / starting current	[Ia/I _n] 4,0
Drehzahl / speed	[upm]	1340	Kipp- zu Nennmoment / pull-out torque	[MK/M _n] 2,4
Anzahl der Pole/ number of poles		4	Anzugs- zu Nennmoment / starting torque	[Ma/M _n] 2,3
Nennstrom / rated current (400V)	[A]	0,35	Trägheitsmoment / moment of inertia	[Kg ²] 0,00016
Leistungsfaktor / power factor	[cos φ]	0,62	Lager / bearing	[DE] 6201 [NDE] 6201
Wirkungsgrad / efficiency	[100%] [75%] [50%]	40 0 0	max. Radialbelastung / max. radial force	[N] 450
Schutzart / degree of protection	[IP]	IP 55	Schalleistungspegel / noise level	[dB] 52
Drehmoment / torque	[Nm]	0,4	Umgebungstemperatur / ambient temperature	[°C] ≤40
Betriebsart / type of duty		S1	Gewicht / weight	[kg] 2,9
Iso.Kl		F	Aufstellungshöhe / altitude	[m] ≤1000
max. Temperaturanstieg / temperature rise	[K]	≤65		
Frequenz / frequency	[Hz]	50/60		
Spannung / voltage		230/400 [Δ/Y] 50Hz 265/460 [Δ/Y] 60Hz		
Motorschutz / motor protection		3xPTC Kaltleiter		
Herstellungsjahr / production year		siehe Seriennummer 1. vier Stellen / see serial number 1. four digits		