

IEC 34-30

Maßblatt Drehstrommotor / dimensions three phase motor IM B3 [mm]

Typ	A	AB	AC	B	BB	C	PM	ØD	DB	E	F	H	HD	K	L
SEV-200Lx-6	318	395	410	305	375	133	2-M50x1.5	55	M20	110	16	200	505	18,5	770

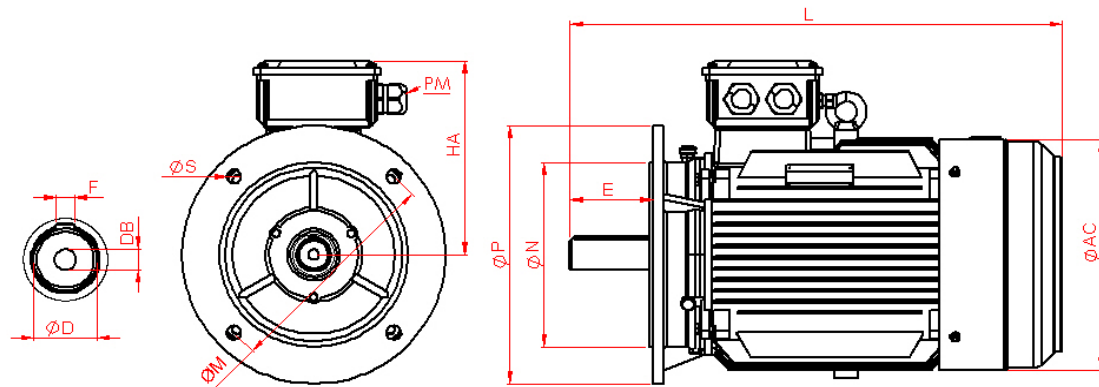

IE3

IEC 34-30

Maßblatt Drehstrommotor / dimensions three phase motor IM B5 [mm]

Typ	AC	ØD	DB	E	F	HA	PM	L	ØP	ØN	ØM	ØS
SEV-200Lx-6	410	55	M20	110	16	305	2-M50x1.5	770	400	300	350	19

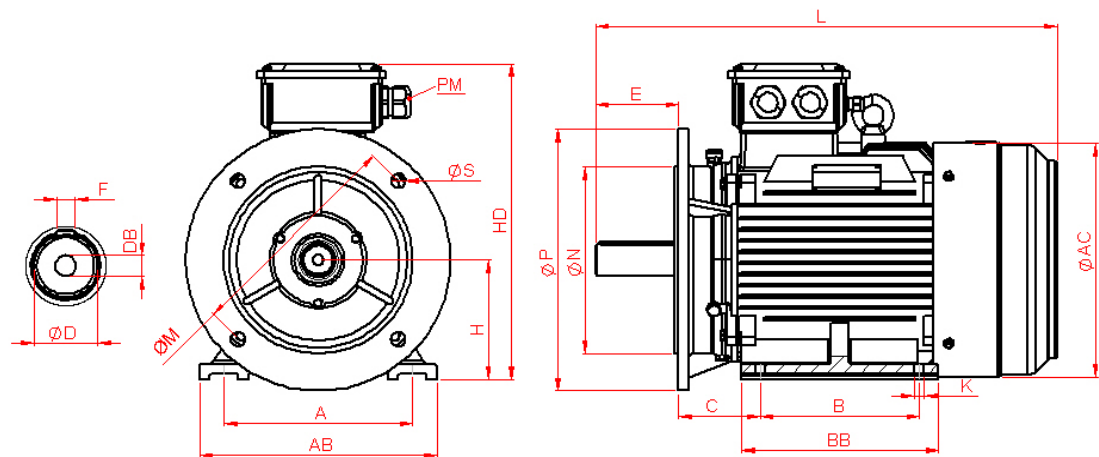

IE3

IEC 34-30

Maßblatt Drehstrommotor / dimensions three phase motor IM B35 [mm]

Typ	A	AB	AC	B	BB	C	PM	ØD	DB	E	F	H	HD	K	L
SEV-200Lx-6	318	395	410	305	375	133	2-M50x1.5	55	M20	110	16	200	505	18,5	770
											ØP	ØN	ØM	ØS	
											400	300	350	19	

technische Daten / technical data

Typ / type	SEV-200Lx-6				
Leistung / power	[kW]	22	Anzugs- zu Nennstrom / starting current	[Ia/In]	7,4
Drehzahl / speed	[upm]	980	Kipp- zu Nennmoment / pull-out torque	[MK/Mn]	2,1
Anzahl der Pole/ number of poles		6	Anzugs- zu Nennmoment / starting torque	[Ma/Mn]	2,0
Nennstrom / rated current (400V)	[A]	42,56	Trägheitsmoment / moment of inertia	[Kgm ²]	0,362
Leistungsfaktor / power factor	[cos φ]	0,81	Lager / bearing	[DE] [NDE]	6312 6212
Wirkungsgrad / efficiency	[100%] [75%] [50%]	92,2 92,2 89,8	max. Radialbelastung / max. radial force	[N]	4420
Schutzart / degree of protection	[IP]	IP55	Schallleistungspegel / noise level	[dB]	76
Drehmoment / torque	[Nm]	214,4	Umgebungstemperatur / ambient temperature	[°C]	-15°C/+40°C
Betriebsart / type of duty		S1	Gewicht / weight	[kg]	B3 = 245 B5 = 248 B35 = 258
Iso.Kl		F	Aufstellungshöhe / altitude	[m]	≤1000m
max. Temperaturanstieg / temperature rise	[K]	<80K			
Frequenz / frequency	[Hz]	50/60 Hz			
Spannung / voltage		400/690 [Δ/Y] 50Hz 460/796 [Δ/Y] 60Hz			
Motorschutz / motor protection		3 x PTC Kaltleiter			
Herstellungsjahr / production year		siehe Seriennummer 1. vier Stellen see serial number 1. four digits			